

# Technical Data Sheet ECOTROL<sup>®</sup> Control Valve

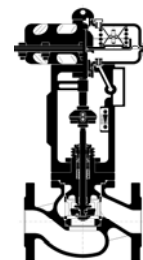

TD\_6N

## General Data

<b>Series</b>	<b>6N</b>
<b>Nominal Size DN /NPS</b>	<b>150-500 / 6" – 20"</b>
<b>Nominal Pressure PN / ANSI</b>	<b>10-40 / Class 150-300</b>
<b>Characteristics</b>	equal percentage or linear
<b>Rangeability</b>	40:1
<b>Plug guide</b>	stem guided, option: double guiding (retrofit able)
<b>Seat leakage</b>	metal sealing: IEC 50534-4 leakage class IV (0,01% kVs- value); option: leakage class V soft sealing: IEC 50534-4 leakage class VI
<b>Bellow sealing (option)</b>	seamless, double walled, made of 1.4571, option: Hastelloy and other materials
<b>Heating jacket (option)</b>	Connections DN 15 PN 40 (1/2" ANSI 300) flanges
<b>Low temperature design (option)</b>	Down to -196°C

## Materials

Body Materials	EN	Temperature range	ASTM	Temperature range	
	1.0619 GP240GH*	-10 to 400°C	A 216 WCB*	-29°C to 400°C	
	1.4408 G-X 5 CrNiMo 19 11 2	-196 to 400°C	A 351 CF8M*	-196°C to 400°C	
	1.4581 GX5CrNiMoNb 19-11-2*	-10 to 450°C	-	-	
	1.6220 G20Mn5	-40 to 400°C	A 352 LCB	-50°C to 400°C	
	1.6982 GX3CrNi13-4	-120 to 400°C	-	-	
	1.7357 G17CrMo5-5	-10 to 530°C	A 217 WC6	-29°C to 530°C	
<b>Bonnet Materials</b>	Same material as body, stuffing box sleeve made of 1.4571 (AISI 316TI)				
<b>Trim material</b>					
Material No.	Parabolic Plug	Perforated plug L1	Seat	Seat sealing	Max. fluid temperature
1	1.4122*	1.4122 nitrided	1.4021*	metallic	same as stem sealing
2	1.4571*	1.4571 nitrided	1.4571*	metallic	same as stem sealing
3	1.4112 hardened	1.4112 hardened	1.4112 hardened	metallic	same as stem sealing
4	1.4122*	1.4122 nitrided	1.4021*	PTFE/FKM	-50 ~ 160°C
5	1.4571*	1.4571 nitrided	1.4571*	PTFE/FKM	-50 ~ 160°C
6	1.4112 hardened	1.4112 hardened	1.4112 hardened	PTFE/FKM	-50 ~ 160°C
7	1.4122*	1.4122 nitrided	1.4021*	PTFE/EPDM	-50 ~ 140°C
8	1.4571*	1.4571 nitriert	1.4571*	PTFE/EPDM	-50 ~ 140°C
9	1.4112 hardened	1.4112 hardened	1.4112 hardened	PTFE/EPDM	-50 ~ 140°C
10	1.4122*	1.4122 nitrided	1.4021*	PTFE	-196 ~ 180°C
11	1.4571*	1.4571 nitrided	1.4571*	PTFE	-196 ~ 180°C
12	1.4112 hardened	1.4112 hardened	1.4112 hardened	PTFE	-196 ~ 180°C

\* Standard

# Technical Data Sheet ECOTROL® Control Valve

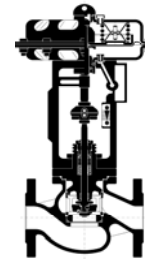

TD\_6N

## Temperature range for stem sealings

Sealing type	Packing Ring (Item A)	Micro sealing (Item B)	O-Ring (Item C)	Wiper ring (Item D)	Temp. range	Top flange design	Remarks
Maintenance free double sealing	PTFE V-Ring	EPDM (FKM)	EPDM	NBR	-25 ~ 180 (200)°C	Standard	preloaded c/w stainless steel spring
adjustable	reinforced Graphite/ Inconel	-	-	NBR (FKM)	-29 ~ 400°C	Standard/ Cooling fins	Standard operation
adjustable	Pure Graphite	-	-	VITON	-29 ~ 530°C	Standard/ Cooling fins	high temperature
adjustable	Braided Graphite/ PTFE	-	-	NBR	-196 ~ 200°C	Extended bonnet	low temperature
Bellow sealing c/w double safety sealing	PTFE V-Ring/ bellow (1.4571 or Hastelloy C)	EPDM (FKM)	EPDM	NBR (FKM)	-100 ~ 200°C	Bellow sealing	preloaded c/w stainless steel spring

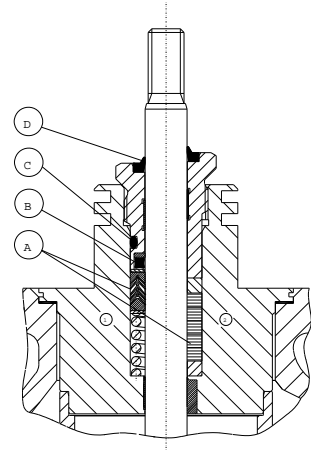

## Weights and dimensions

Dimensions (mm) of valves c/w flanges acc. to DIN EN 1092-1 or ANSI Class 150/300 RF/RTJ									
Valve Series 6N	DN	150	200	250	300	350	400	500	
	ANSI NPS	6"	8"	10"	12"	14"	16"	20"	
	VBL PN10-PN40	480	600	730	850	980	1100	1250	
	VBL Class 150 RF	450,8	542,9	673,1	736,6	889	1016	1250	
	VBL Class 150 RTJ	463,5	555,7	-	-	-	-	-	
	VBL Class 300 RF	472,9	568,3	708	774,7	927,1	1057,3	1250	
	VBL Class 300 RTJ	488,9	584,1	-	-	-	-	-	
	VH	DEK1	260	295	360	395	465	520	600
		DEK2	355	410	510	545	615	670	1)
		DEK3	355	410	510	545	615	670	1)
DEK4		575	605	850	850	880	1)	1)	
DEK5		on request							
DEK7		260	295	360	395	465	520	600	
VU	DEK8	355	410	510	545	615	670	1)	
	VU	190	240	305	335	395	445	540	
Actuator <sup>2)</sup> Type 812/811/MA	ØA	MFIII	400						
		UV	530						
		MA.60	596						
	AH	MFIII	625						
		UV	1006		1135				
		MA.60	840		1010				
	AHV	MFIII	888						
		UV	1323		1452				
		B	200		340				
	weight* ca. kg	MFIII	247	332					
		UV	250	350	535	830	1160	1460	
		MA.60	330	390	600	1000	1300	1770	2500

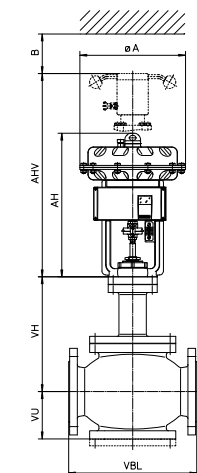
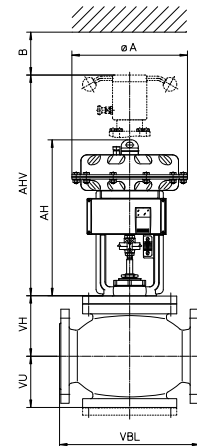

1) On request

2) Actuator type for DN500/ 20" on request

\*) valve c/w actuator w/o hand wheel

# Technical Data Sheet ECOTROL<sup>®</sup> Control Valve

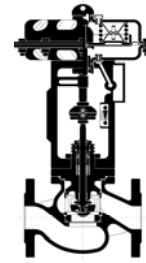

TD\_6N

## Standard kVs/ Cvs and seat diameters of series 6N (not balanced)

DN/ NPS	Seat-Ø (mm)	Characteristics	kVs [m³/h]		Cvs [gal/min]	
			Parabolic Plug	Perforated Plug	Parabolic Plug	Perforated Plug
150 6"	90	= %	150	125	157	146
		linear		170		199
	113	= %	260	150	304	175
		linear		260		304
	143	= %	380	210	445	246
		linear		380		445
200 8"	113	= %	260	150	304	175
		linear		260		304
	143	= %	380	210	445	246
		linear		380		445
	172	= %	650	260	761	304
		linear		450		523
250 10"	143	= %	380	210	445	246
		linear		380		445
	172	= %	650	260	761	304
		linear		450		526
	220	= %	900	520	1053	608
		linear		900		1053
300 12"	172	= %	650	260	761	304
		linear		450		526
	220	= %	900	520	1053	608
		linear		900		1053
	282	= %	1300	720	1521	842
		linear		1300		1521
350 14"	220	= %	900	520	1053	608
		linear		900		1053
	282	= %	1300	720	1521	842
		linear		1300		1521
	313	= %	1800	850	2106	995
		linear		1800		2106
400 16"	282	= %	1300	720	1521	842
		linear		1300		1521
	313	= %	1800	850	2106	995
		linear		1800		2106
	400	= %	2500	1250	2925	1462
		linear		2500		2925
500 20"	400	= %	2500	1250	2925	1462
		linear		2500		2925
	500	= %	4000	-	4680	-
		linear		4000		4680

# Technical Data Sheet ECOTROL® Control Valve

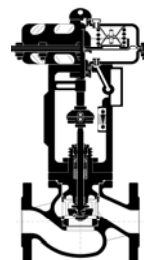

TD\_6N

Max. shut off differential pressures (valve closed)  
(PTFE packing (V-Ring), leakage class IV, w/o balancing, <sup>1)</sup> flow-to-open)

Actuator series 812 Type MFIII - 60 (multi-spring actuator)		Air to open / Spring to close No. of springs				Air to close / spring to open No. of springs				
		3	6	9	12	3	3	3	6	6
DN/ NPS	Seat-Ø (mm)	bar				p <sub>instrument air, min</sub> [bar]				
						3,0	4,5	6,0	4,5	6,0
150 6"	90	4,9	12,7	17,4	22,2	14,0	31,0	47,9	14,0	31,0
	113	2,7	7,7	10,7	13,7	8,5	19,3	30,1	8,5	19,3
	143	1,4	4,5	6,4	8,3	5,0	11,7	18,5	5,0	11,7
200 8"	113	2,7	7,7	10,7	13,7	8,5	19,3	30,1	8,5	19,3
	143	1,4	7,7	6,4	8,3	5,0	11,7	18,5	5,0	11,7
	172	0,8	2,9	4,2	5,5	3,3	7,9	12,6	3,3	7,9

Actuator series 811 Type UV-60 (single-spring actuator)		Air to open / Spring to close spring				Air to close / spring to open spring				
		standard		reinforced		standard			reinforced	
DN/ NPS	Seat-Ø (mm)	Min.	Max.	Min.	Max.	p <sub>instrument air, min</sub> [bar]				
		bar	bar	bar	bar	3,0	4,5	6,0	4,5	6,0
150 6"	90		19,2		35,8	48,6	50,0	50,0	50,0	50,0
	113		11,8		22,4	30,5	50,0	50,0	36,5	50,0
	143		7,1		13,7	18,7	32,2	45,8	22,5	36,0
200 8"	113		11,8		22,4	30,5	50,0	50,0	36,5	50,0
	143		7,1		13,7	18,7	32,2	45,8	22,5	36,0
	172		4,7		9,3	12,7	22,0	31,4	15,4	24,7

Actuator series 811 Type UV-100 (single-spring actuator)		Air to open / Spring to close spring				Air to close / spring to open spring				
		standard		reinforced		standard			reinforced	
DN/ NPS	Seat-Ø (mm)	Min.	Max.	Min.	Max.	p <sub>instrument air, min</sub> [bar]				
		bar	bar	bar	bar	3,0	4,5	6,0	4,5	6,0
250 10"	143		3,3		6,8	17,3	30,7	44,2	22,3	35,7
	172		2,1		4,5	11,8	21,1	30,4	15,2	24,5
	220		1,1		2,6	7,0	12,7	18,4	9,1	14,8
300 12"	172		2,1		4,5	11,8	21,1	30,4	15,2	24,5
	220		1,1		2,6	7,0	12,7	18,4	9,1	14,8
	282		0,5		1,4	4,1	7,6	10,0	5,4	8,8
350 14"	220		1,1		2,6	7,0	12,7	18,4	9,1	14,8
	282		0,5		1,4	4,1	7,6	10,0	5,4	8,8
	313		0,3		1,1	3,3	6,1	8,9	4,3	7,1

Actuator series 811 Type UV-120 (single-spring actuator)		Air to open / Spring to close spring				Air to close / spring to open spring				
		standard		reinforced		standard			reinforced	
DN/ NPS	Seat-Ø (mm)	Min.	Max.	Min.	Max.	p <sub>instrument air, min</sub> [bar]				
		bar	bar	bar	bar	3,0	4,5	6,0	4,5	6,0
400 16"	282	-	-	-	0,5	4,1	7,6	11,0	5,4	8,8
	313	-	-	-	0,3	3,3	6,1	8,9	4,3	7,1
	400	-	-	-	-	1,9	3,6	5,3	2,5	4,2

<sup>1)</sup> For higher differential pressures, balanced trim is required. Please contact ARCA!

# Technical Data Sheet ECOTROL<sup>®</sup> Control Valve

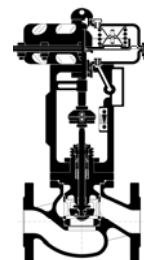

TD\_6N

Max. shut off differential pressures (valve closed)  
(PTFE packing (V-Ring), leakage class IV, w/o balancing, <sup>1)</sup> flow-to-open)

Actuator series MA60.D (multi-spring actuator)		Air to open / Spring to close No. of springs				Air to close / spring to open No. of springs				
		2	4	6	8	2	2	2	4	4
DN/ NPS	Seat-Ø (mm)	bar				p instrument air, min [bar]				
		3,0	4,5	6,0	4,5	6,0				
150 6"	90	12,7	28,4	44,2	50,0	50,0	50,0	50,0	-	-
	113	7,7	17,7	27,7	37,6	47,6	50,0	50,0	-	-
	143	4,5	10,7	17,0	23,2	29,4	41,9	50,0	-	-
200 8"	113	7,7	17,7	27,7	37,6	47,6	50,0	50,0	-	-
	143	4,5	10,7	17,0	23,2	29,4	41,9	50,0	-	-
	172	2,9	7,2	11,5	15,8	20,2	28,8	37,4	-	-
250 10"	143	4,5	10,7	17,0	23,2	29,4	41,9	50,0	-	-
	172	2,9	7,2	11,5	15,8	20,2	28,8	37,4	-	-
	220	1,4	3,9	6,4	8,7	11,8	18,6	25,4	-	-
300 12"	172	2,9	7,2	11,5	15,8	20,2	28,8	37,4	-	-
	220	1,4	3,9	6,4	8,7	11,8	18,6	25,4	-	-
	282	0,7	2,2	3,7	5,2	7,0	11,2	15,3	-	-
350 14"	220	1,4	3,9	6,4	8,7	11,8	18,6	25,4	-	-
	282	0,7	2,2	3,7	5,2	7,0	11,2	15,3	-	-
	313	0,5	1,7	2,9	4,1	5,6	9,0	12,4	-	-
400 16"	282	0,7	2,2	3,7	5,2	7,0	11,2	15,3	-	-
	313	0,5	1,7	2,9	4,1	5,6	9,0	12,4	-	-
	400	-	0,4	0,9	1,3	3,3	5,4	7,5	-	-

# Technical Data Sheet ECOTROL® Control Valve

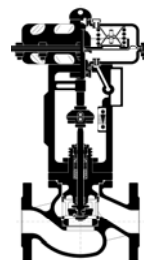

TD\_6N

## ECOTROL® 6N type code

0. Operating Conditions		7. Body materials (cont.)		16. Seat/ plug seal <sup>1)</sup>	
Fluid:		6	A216WCB	0	Leakage class IV (metal to metal)
Temp.:	°C	7	A351CF8M	1	Leakage class V (metal, super finished)
Press. P <sub>1</sub> :	bar abs	8	A217WC6	2	Soft sealed (PTFE/EPDM)
Press. P <sub>2</sub> :	bar abs	9	other (in acc. with order)	3	Soft sealed (PTFE/FKM)
<b>1. Series</b>		<b>8. Guiding <sup>1)</sup></b>		<b>4</b>	
6N		0 Stem guided (standard)		9 other (in acc. with order)	
<b>2. Bonnet</b>		1 Bottom guided		<b>17. Cage Retainer <sup>1)</sup></b>	
1 Standard		9 other (in acc. with order)		0 Standard	
2 Double stuffing box		<b>9. kVs</b>		1 LN (Low Noise), not controlled	
3 Cooling fins		xxx in acc. with order		2 LN controlled	
4 Bellows		<b>10. Characteristics</b>		9 other (in acc. with order)	
5 Extension (insulating column)		l Linear		<b>18. Low noise cage <sup>1)</sup></b>	
7 Standard balanced		g =%		1 LK1	
8 Cooling fins balanced		m modified		2 LK2	
9 Special design in acc. with order		s On/ Off		3 LK3	
<b>3. Plug design</b>		<b>11. Plug materials <sup>1)</sup></b>		4 LK4	
P1-P3-P5 Parabolic plug (1-3-5 step)		1 1.4571		5 SLK1	
L1-L2-L3 Perforated plug (1-2-3 step)		3 1.4112		6 SLK2	
S On/ Off plug		4 1.4122		9 other (in acc. with order)	
<b>4. Nominal diameter (DN) – DIN/ ANSI</b>		9 other (in acc. with order)		<b>19. Stem sealing <sup>1)</sup></b>	
150	DN 150 / ANSI 6"	<b>12. Plug wear/ tear protection <sup>1)</sup></b>		1 PTFE/V-Ring/EPDM quad ring	
200	DN 200 / ANSI 8"	0 Standard (w/o)		2 PTFE/V-Ring/VITON quad ring	
250	DN 250 / ANSI 10"	1 nitrided		3 Latty 6118/ETF Inconel	
300	DN 300 / ANSI 12"	2 hardened		4 Graphite 0901	
350	DN 350 / ANSI 14"	3 Plug face stellite		5 Graphite/PTFE 6226/6232	
400	DN 400 / ANSI 16"	4 Completely stellite		9 other (in acc. with order)	
500	DN 500 / ANSI 20"	5 Colsterised		<b>20. special design</b>	
<b>5. Nominal pressure (PN)</b>		9 other (in acc. with order)		0 Standard	
10	PN 10	<b>13. Balancing <sup>1)</sup></b>		1 AD2000	
16	PN 16	1 Piston rings		2 NACE	
40	PN 40	2 EPDM- quad ring		3 Oxygen design	
150	Class 150 acc. to ANSI B16.10	3 FKM- quad ring		9 other (in acc. with order)	
300	Class 300 acc. to ANSI B16.10	5 PTFE spring loaded		<b>21. Material inspection (pressure retaining parts)</b>	
<b>6. Connections</b>		9 other (in acc. with order)		0 w/o	
0	Flanges c/w sealing strip RF SF	<b>14. Seat materials</b>		1 EN 10204-2.1	
1	Flanges c/w groove	1 1.4571		2 EN 10204-3.1	
2	Flanges c/w tongue	3 1.4112		3 EN 10204-3.2	
3	Flanges c/w projection/ recess	4 1.4122		9 other (in acc. with order))	
4	Butt weld ends	9 other (in acc. with order)		<b>22. Final inspection</b>	
5	Butt weld ends c/w spool pieces	<b>15. Seat wear/ tear protection <sup>1)</sup></b>		0 w/o	
7	RTJ	0 standard (w/o)		1 EN 10204-2.1	
9	other (in acc. with order)	1 nitrided		2 EN 10204-2.2	
<b>7. Body materials <sup>1)</sup></b>		2 hardened		3 EN 10204-3.1	
2	1.0619	3 Seat face stellite		4 EN 10204-3.2	
3	1.4581	4 Completely stellite		9 other (in acc. with order)	
4	1.7357	5 Colsterised			
5	1.6620	9 other (in acc. with order)			

<sup>1)</sup> in accordance with customer's specification, or selected by manufacturer in accordance with customer's specification (fluid, pressure, etc.)

### Example:

**6N - 1 - P1 - 150 - 40 - 0 - 2** Position 1-7 / basic data

Series 6N – c/w standard bonnet – c/w parabolic plug - DN150 – PN40 – flanges acc. to EN1092 B1 – body 1.0619

**0 - 260 - g - 1 - 0 - 0 - 1 - 0 - 0 - 0 - 0 - 1** Position 8-19 / trim

Single stem guiding – kVs 260 – equal percentage – plug made of 1.4571 – w/o wear/tear protection – w/o balancing – seat made of 1.4571 – w/o wear/ tear protection – leakage class IV – cage retainer standard – w/o low noise cage – stem sealing PTFE-V-Ring/EPDM quad ring

**0 - 1 - 1** position 20-22 / Design/ inspections

Standard design – Material inspection acc. to EN 10204 3.1 - Final inspection acc. to EN 10204 3.1